

**SELEC**<sup>®</sup>  
Creating Best Value



# MFM374

## Multifunction Meter

# OPERATING INSTRUCTIONS

<b>1. INTRODUCTION</b>	
1.1 About MFM374.....	01
1.2 Overview.....	02
1.3 Technical Overview.....	04
1.4 Installation Guide.....	08
1.5 Wiring Guide.....	11
<b>2. HUMAN MACHINE INTERFACE (HMI).....</b>	<b>15</b>
<b>3. CONFIGURATION.....</b>	<b>21</b>
<b>4. APPLICATIONS.....</b>	<b>29</b>
<b>5. COMMUNICATION</b>	
5.1 Modbus Parameter.....	30
<b>6. USER GUIDE.....</b>	<b>38</b>
<b>7. CONFIG RECORD SHEET.....</b>	<b>39</b>



# Introduction



## ABOUT MFM374

A suitable meter for the measurement of parameters such as voltage, current, power factor, frequency, power and energy. Features such as pulse output, communication are available thereby providing a complete solution for many measurement needs.

### APPLICATIONS:

1. Electric Automation SCADA System:

MFM374 can be used as Remote Terminal Unit (RTU) for monitoring purpose in a SCADA System. All measured data is available through RS485 communication ports with the Modbus Protocol.

2. Energy Management System / Building Management System:

MFM374 can be used to monitor power and energy parameters of an organizations which can be transmitted to main control room through RS485

3. Heavy Industries:

MFM374 is a suitable meter for heavy industries because of its ability to function even in rough conditions.

4. Power Transmission and Distribution field

5. Power System Protection Field

6. Industry Automation

7. Large UPS System

**Note:** Please read this manual carefully & completely before installing / operating MFM374.

**Specifications are subject to change as development is a continuous process**

## Overview



### SALIENT FEATURES

- 3 rows of 4 digits
- Network supported: 1Ø-2 wire, 2Ø-3 wire, 3Ø-3 wire, 3Ø-4 wire
- User programmable network selection
- 7-segment red LED display
- Auto / manual page scrolling
- User programmable page sequence for page displayed in auto mode
- Measures all electrical parameters (True RMS Voltage, True RMS Current, Active power, Reactive power, Apparent power, Power factor, Frequency, Active energy, Reactive energy & Apparent energy )
- Programmable CT/ PT primary, CT/PT secondary
- Memory retention for ten years
- Potential free Pulse output for energy
- 85 to 270V AC auxiliary supply
- RS485 communication (MODBUS Protocol), (Optional)
- Protection covering for terminal screws

### ORDER CODE:

- 1) MFM 374
- 2) MFM 374-C (With communication version)

## Overview

## Display &amp; Key description

- 3 lines of seven segment digits in metering area  
Display parameters such as Voltage, Current, Power factor, Power & Frequency, Energy
- Unit (V, A, PF, Hz, kW, kVAr, kVA)  
Indicates unit of parameter displayed



Voltage: V, kV		Current: A, kA
Active Power: kW, MW		Reactive power: kVAr, MVAR
Apparent power: kVA, MVA		Frequency: Hz,
Active energy: kWh, MWh		Reactive energy: kVArh, MVARh
Apparent energy: kVAh, MVAh		

- Keypad: keypad with four dual function keys (HMI or Programming)
- Display: Bright red LED display for best vision
- Phase (1, 2, 3, 1-2, 2-3, 3-1) : Display phase to neutral or phase to phase values

### Technical Overview

### Functional Descriptions

<b>Description</b>	<b>MFM374</b>
<b>Display</b>	<ul style="list-style-type: none"> <li>▶ 7 segment bright red LED display</li> <li>▶ 3 lines, 4 digits per line to show electrical parameters</li> </ul>
<b>LED Indications</b>	LED indication for all electrical parameter such as V, I, PF, Hz, kW, kVA, kVA <sub>r</sub> , kWh, kVA <sub>h</sub> , kVA <sub>r</sub> h, k (kilo), M(mega), avg, tot, L1, L2, L3
<b>Display update time</b>	1 sec for all parameters
<b>Display Scrolling</b>	Auto / Manual
<b>Online Pages</b>	Customized page selection from available standard pages (selection via configuration menu)

### Input Point Electrical Specification

<b>Electrical input type</b>	1 Ø-2 wire, 2 Ø-3 wire, 3 Ø-3 wire, 3 Ø-4 wire
<b>Rated input voltage</b>	11 to 300V AC max phase to neutral 19 to 519V AC max phase to phase
<b>Rated input current</b>	Nominal 5A AC (11mA minimum) 6A max (External CT is advised to connect)
<b>Frequency range</b>	45 to 65 Hz
<b>CT Primary</b>	1A or 5A to 10,000A (Programmable for any value) Note: 1A or 5A depends upon the CT secondary
<b>CT Secondary</b>	Programmable 1A or 5A
<b>PT Primary</b>	100V to 500kV (Programmable for any value)
<b>PT Secondary</b>	100 to 500V AC (L-L) Programmable for any value
<b>Burden</b>	0.5 VA per phase @ 5A

<b>Serial Communication (Optional)</b>	
<b>Interface standard &amp; protocol</b>	MODBUS RTU protocol over RS485
<b>Communication address</b>	1 to 255
<b>Transmission mode</b>	Half duplex
<b>Data types</b>	Float and Integer
<b>Transmission distance</b>	500 m maximum
<b>Transmission speed</b>	300, 600, 1200, 2400, 4800, 9600, 19200 (in bps)
<b>Parity</b>	None, Odd, Even
<b>Stop bits</b>	1 or 2
<b>Response time</b>	100 ms (Independent of baud rate)

<b>Pulse Output</b>	
<b>Pulse Output (type)</b>	Opto-Isolated
<b>Pulse Voltage</b>	24V DC max.
<b>Pulse Current</b>	100mA max.
<b>Pulse Width</b>	100 ms $\pm$ 50 ms.

<b>General Specification</b>	
<b>Auxiliary Supply</b>	85 to 270V AC/DC
<b>Operating frequency</b>	50/60Hz
<b>Power Consumption</b>	0.5 VA max. @5A per phase
<b>Temperature</b>	Operating temperature: 0 to +50°C Storage temperature: -20 to +75°C
<b>Humidity</b>	85% RH
<b>Mounting</b>	Panel mounting
<b>Weight</b>	320 gms



Parameter Measured / Calculated		
Parameters	Measured values	Unit
Voltage	V1N, V2N, V3N, V12, V23, V31, Vavg L-N, Vavg L-L	V
Current	$I_1, I_2, I_3, I_{AVG}$	A
Active Power	kW <sub>1</sub> , kW <sub>2</sub> , kW <sub>3</sub> and Total kW	kW
Reactive Power	kVAR <sub>1</sub> , kVAR <sub>2</sub> , kVAR <sub>3</sub> and Total kVAR	kVAR
Apparent Power	kVA <sub>1</sub> , kVA <sub>2</sub> , kVA <sub>3</sub> and Total kVA	kVA
Power Factor	Individual and average	-
Frequency	Frequency of available phase	Hz
Active Energy	Total of all phases	kWh
Reactive Energy	Total of all phases	kVARh
Apparent Energy	Total of all phases	kVAh

Resolution Table		
PT Ratio x CT Ratio	kWh	Pulse
<15	0.01K	0.01K
<150	0.1K	0.1K
<1500	1K	1K
<15000	0.01M	0.01M
<150000	0.1M	0.1M
≥1500000	1M	1M

**NOTE:**

- 1) For voltage, Current, Power, resolution is automatically adjusted
- 2) For power factor, resolution is 0.001

Accuracy	
Measurement	Accuracy
Voltage $V_{L-N}$	$\pm 0.5\%$ of F.S. +1 digit
Voltage $V_{L-L}$	$\pm 0.5\%$ of F.S. +1 digit
Average Voltage $V_{L-N}$	$\pm 0.5\%$ of F.S. +1 digit
Average Voltage $V_{L-L}$	$\pm 0.5\%$ of F.S. +1 digit
Current	$\pm 0.5\%$ of F.S. +1 digit
Average current	$\pm 0.5\%$ of F.S. +1 digit
Frequency	$\pm 0.1\%$ for $V > 20V$ (L-N) $\pm 0.1\%$ for $V > 35V$ (L-L)
Active Power	Class 1
Apparent power	Class 1
Reactive Power	Class 1
Power factor & Avg Pf	$\pm 0.01$ PF
Active energy	Class 1
Reactive energy	Class 1
Apparent energy	Class 1

**Toll free:** 1800 227 353

**Phone:** 91-22-28471 1882 / 4039 4200 / 4039 4202

**Email:** sales@selec.com

## Installation Guide

## Safety Precautions

All safety related codifications, symbols and instructions that appear in this operating manual or on the equipment must be strictly followed to ensure the safety of the operating personnel as well as the instrument.

If the equipment is not handled in a manner specified by the manufacturer it might impair the protection provided by the equipment.

 **CAUTION:** Read complete instructions prior to installation and operation of the unit.

 **CAUTION:** Risk of electric shock.

## WIRING GUIDELINES

 **WARNING:**

1. To prevent the risk of electric shock power supply to the equipment must be kept OFF while doing the wiring arrangement.
2. Wiring shall be done strictly according to the terminal layout. Confirm that all connections are correct.
3. Use lugged terminals.
4. To eliminate electromagnetic interference use of wires with adequate ratings and twists of the same in equal size shall be made.
5. Cable used for connection to power source, must have a cross section of  $1.5\text{mm}^2$ . These wires shall have current carrying capacity of 6A.
6. The following safety earth symbol is used in this user's manual: 

## Maintenance

1. The equipment should be cleaned regularly to avoid blockage of ventilating parts.
2. Clean the equipment with a clean soft cloth. Do not use Isopropyl alcohol or any other cleaning agent.

## Installation Guidelines

### CAUTION:

1. This equipment, being built-in-type, normally becomes a part of main control panel and in such case, the terminals do not remain accessible to the end user after installation and internal wiring.
2. Conductors must not come in contact with the internal circuitry of the equipment or else it may lead to a safety hazard that may in turn endanger life or cause electrical shock to the operator.
3. Circuit breaker or mains switch must be installed between power source and supply terminals to facilitate power 'ON' or 'OFF' function. However this switch or breaker must be installed in a convenient position normally accessible to the operator.
4. Before disconnecting the secondary of the external current transformer from the equipment, make sure that the current transformer is short circuited to avoid risk of electrical shock and injury.

### CAUTION:

1. The equipment shall not be installed in environmental conditions other than those mentioned in this manual.
2. The equipment does not have a built-in-type fuse. Installation of external fuse of rating 275V AC/1Amp for electrical circuitry is highly recommended.

**Mechanical Installation**

For installing the controller

1. Prepare the panel cutout with proper dimensions as shown.

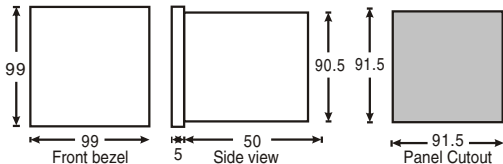

2. Push the meter into the panel cutout. Secure the meter in its place by pushing the clamp on the rear side. The screws, of the pane of the clamp, must be in the farthest forward slot.
3. For proper sealing, tighten the screws evenly with required torque.  
Tightening torque for clamp: 0.1Nm

**! CAUTION:**

The equipment in its installed state must not come in close proximity to any heating sources, caustic vapors, oils, steam, or other unwanted process by-products.

**EMC Guidelines****EMC Guidelines:**

1. Use proper input power cables with shortest connections and twisted type.
2. Layout of connecting cables shall be away from any internal EMI source.

**? SERVICE DETAILS**

This device contains no user serviceable parts and requires special equipment and specialized engineers for repair.

**NO WARRANTY ON UNIT DAMAGED DUE TO WRONG INPUT / OUTPUT WIRING CONNECTION.**

## Terminal Diagram

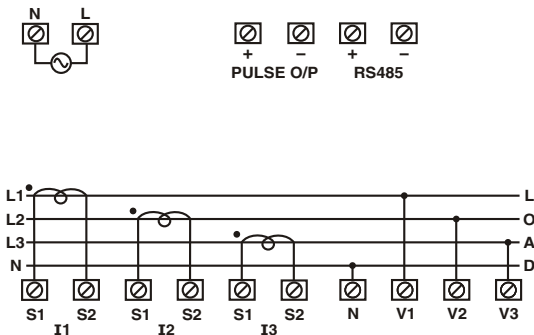

## Wiring guide

### 3 PHASE 4-WIRE (COMMONLY USED) WIRING DIAGRAM

3  $\emptyset$  - 4 wire, 3 CT's

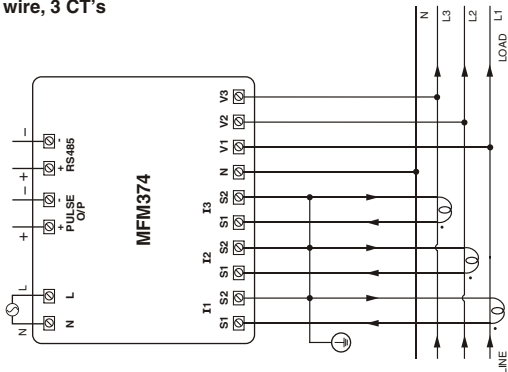

## Wiring Guide

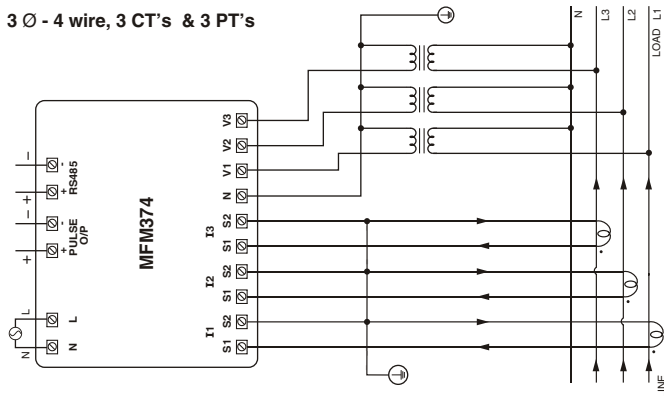
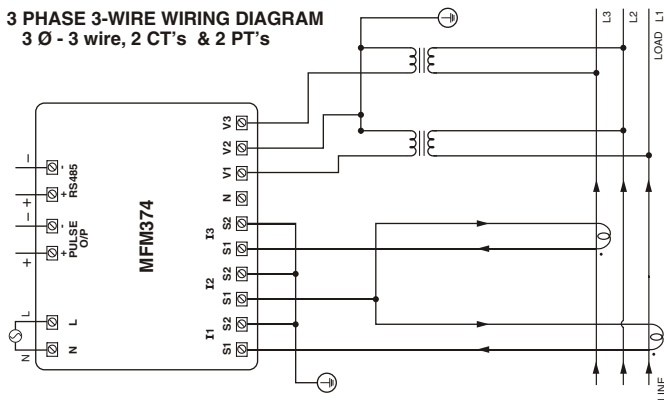
3  $\emptyset$  - 4 wire, 3 CT's & 3 PT's3 PHASE 3-WIRE WIRING DIAGRAM  
3  $\emptyset$  - 3 wire, 2 CT's & 2 PT's

## Wiring Guide

### 2 PHASE 3-WIRE WIRING DIAGRAM

2  $\emptyset$  - 3 wire, 2 CT's

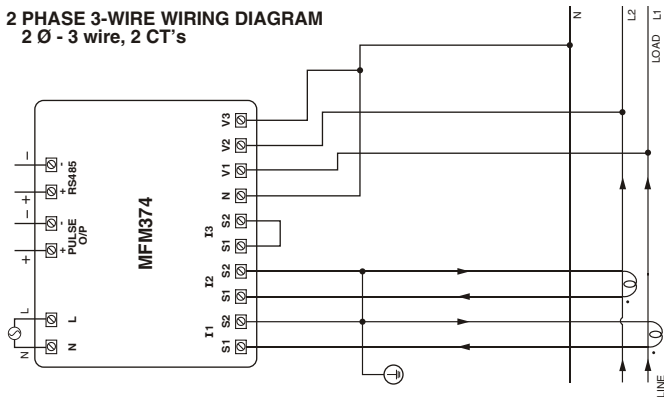

### 2 $\emptyset$ - 3 wire, 2 CT's & 2 PT's

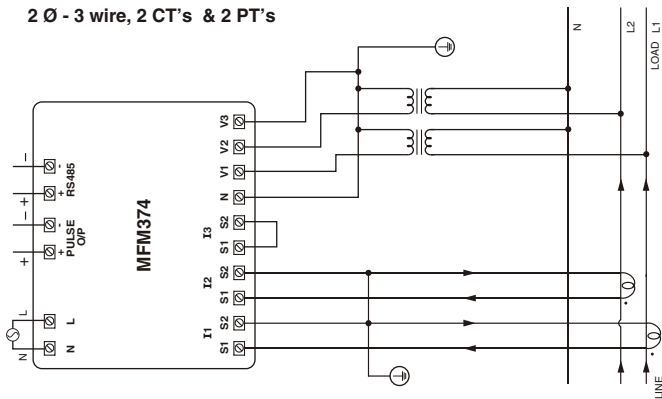

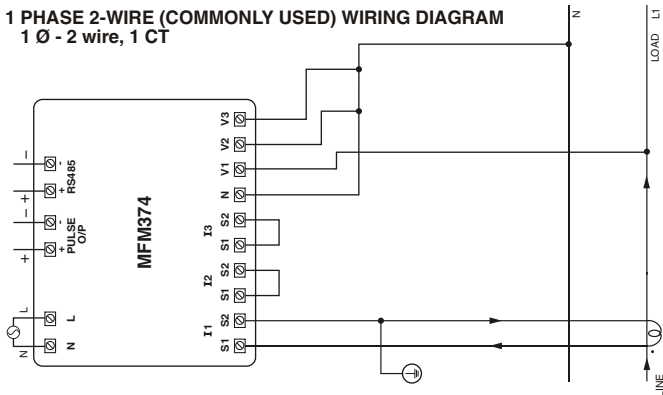

## Wiring Guide

1 PHASE 2-WIRE (COMMONLY USED) WIRING DIAGRAM  
1  $\emptyset$  - 2 wire, 1 CT

## COMMUNICATION WIRING DIAGRAM ( only for MFM374-C )

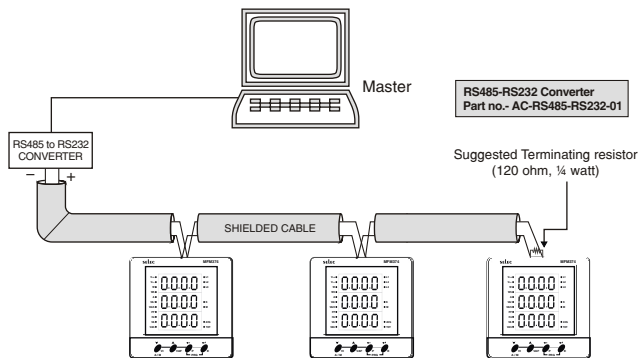

## Online Page Description

There are 4 dedicated keys labelled as VI, VAF, P, E. Use these 4 keys to read meter parameters. Simply press these keys to read the parameters.

01

X1

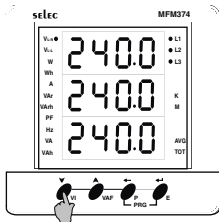

Press VI (♥) button, the first screen shows:

✓ L-N Voltage (V1, V2, V3) of all three phases

**Note:** LED's of the corresponding parameters on display, will glow automatically.

02

X2

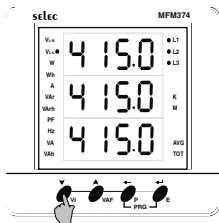

Press VI (♥) button, the second screen shows:

✓ L-L voltage (V 1-2, V 2-3, V 3-1)

03

X3

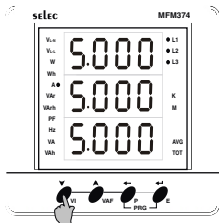

Press VI (♥) button, the third screen shows:

✓ Current (I1, I2, I3)

**Note:** In 3Ø-3 wire system only L-L voltage (V 1-2, V 2-3, V 3-1) current<sub>s</sub> (I 1-2, I 2-3, I 3-1) will be displayed

## Online Page Description

04

X1

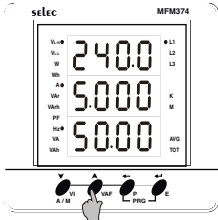

Press VAF (▲) button, the first screen shows:

- ✓ Voltage (L-N), Current of first phase (V1, I1) & Frequency (Hz)

**Note:** In 3 Ø-3 wire system only L-L voltage, L-L current (V 1-2, I 1-2) & Frequency (Hz) will be displayed

05

X2

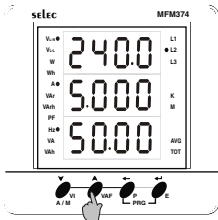

Press VAF (▲) button, the second screen shows:

- ✓ Voltage (L-N), Current of second phase (V2, I2) & Frequency (Hz)

**Note:** In 3 Ø-3 wire system only L-L voltage, L-L current (V 2-3, I 2-3) & Frequency (Hz) will be displayed

06

X3

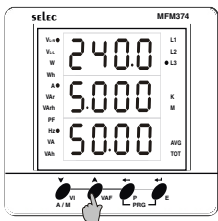

Press VAF (▲) button, the third screen shows:

- ✓ Voltage (L-N), Current of third phase (V3, I3) & Frequency (Hz)

**Note:** In 3 Ø-3 wire system only L-L voltage, L-L current (V 1-3, I 1-3) & Frequency (Hz) will be displayed

## Online Page Description

07

X4

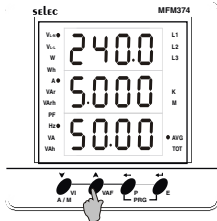

Press VAF (▲) button, the fourth screen shows:

- ✓ Average Voltage (L-N), Current of three phase ( $V_{AVG}$ ,  $I_{AVG}$ ) & Frequency (Hz)

**Note:** In 3Ø-3 wire system only AVG L-L voltage, AVG L-L current, & power factor will be displayed

08

X5

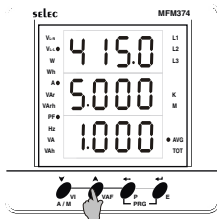

Press VAF (▲) button, the fifth screen shows:

- ✓ Average Voltage (L-L), Current of three phase ( $V_{AVG}$ ,  $I_{AVG}$ ) & power factor

09

X1

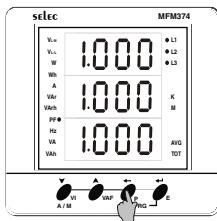

Press P (←) button, the first screen shows:

- ✓ Power factor of all three phases (PF1, PF2, PF3).

**Note:** In 3 Ø-3 wire system only AVG power factor will be displayed

## Online Page Description

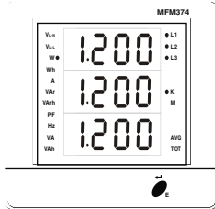

Press P (←) button, the second screen shows:

- ✓ Active Power of all three phases (kW1, kW2, kW3)

**Note:** In 3Ø-3 wire system only Total kW, kVA, kVAR will be displayed

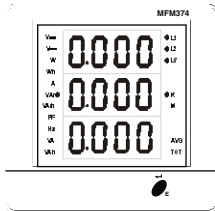

Press P (←) button, the third screen shows:

- ✓ Reactive Power of all three phases (kVAR1, kVAR2, kVAR3)

**Note:** In 3Ø-3 wire system only Total kW, kVA, kVAR will be displayed

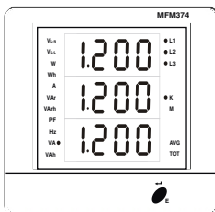

Press P (←) button, the fourth screen shows:

- ✓ Apparent Power of all three phases (kVA1, kVA2, kVA3)

**Note:** In 3Ø-3 wire system only Total kW, kVA, kVAR will be displayed

## Online Page Description

13

X5

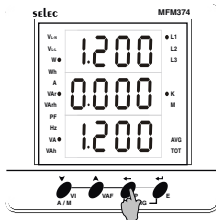

Press P (←) button, the fifth screen shows

- ✓ Active, reactive, apparent power (kW1, kVAR1, kVA1) of first phase.

**Note:** In 3Ø-3 wire system only Total kW, kVA, kVAR will be displayed

14

X6

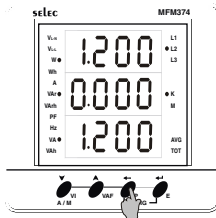

Press P (←) button, the sixth screen shows

- ✓ Active, reactive, apparent power (kW2, kVAR2, kVA2) of second phase.

**Note:** In 3 Ø-3 wire system only Total kW, kVA, kVAR will be displayed

15

X7

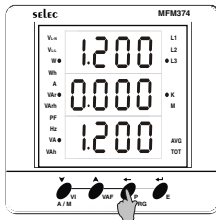

Press P (←) button, the seventh screen shows

- ✓ Active, reactive, apparent power (kW3, kVAR3, kVA3) of third phase.

**Note:** In 3 Ø-3 wire system only Total kW, kVA, kVAR will be displayed

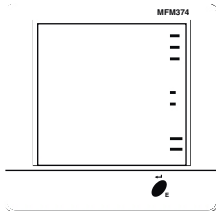
**Configuration**
**Password for entering into configuration****Default Setting:** 1000**Range:** 0000 to 9998

**Note:** Password needed for getting into configuration menu. Only the person who knows the password can do the parameter setting

**Change Password****Default Setting:** No**Range:** No / Yes

**Note:** If user want to change default password, make selection as 'Yes' and proceed. If selection is 'No' then configuration will move on to the network selection page.

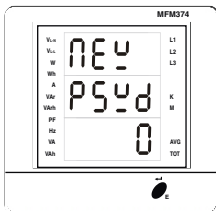
**New Password****Default Setting:** 0000**Range:** 0000 To 9998

**Note:** After selecting 'Yes' on previous page, user can set new password  
Use ▲ or ▼ keys for increasing or decreasing parameters value

# Configuration

## Configuration

04



### Network Selection

**Default Setting:** 3P4W

**Range:** 3P3W and 3P4W

**Note:** For 1Ø-2 wire / 2Ø-3 wire connection the network selection should be set to 3P4W and user can make the requisite hardwired connection at the terminals

05

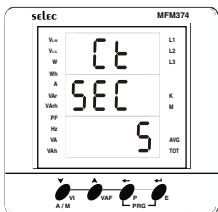

### CT Secondary

**Default Setting:** 5 A

**Range:** 1A or 5A

**Note:** User can select from 1A and 5A as per external CT specification

06

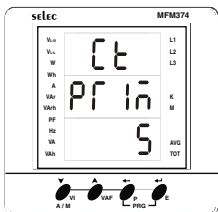

### CT Primary

**Default Setting:** 5 A

**Range:** 1A, 5A to 10,000A (10.0 kA)

**Note:** As per CT secondary selection, CT primary will be 1A to 10000A or 5A to 10000A (Programmable for all values)



## Configuration

07

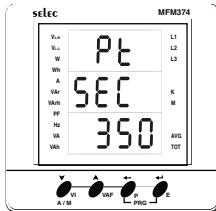

### PT Secondary

**Default Setting:** 350V

**Range:** 100V to 500V

**Note:** User can select from 100 to 500V as per external PT specification (Programmable for all values)

08

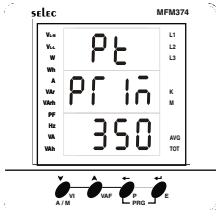

### PT Primary

**Default Setting:** 350V

**Range:** 100V to 500kV

**Note:**

- 1) User can select PT primary value as per external PT specifications (Programmable for all values)
- 2) PT values changes in step of 10 after 9999 and display shows 10.00K and in steps of 100 after 99.99K

09

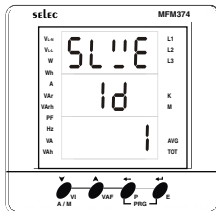

### Slave ID

**Default Setting :** 1

**Range:** 1 to 255

**Note:** Slave Id is for communication purpose. Each meter on same RS485 network should have different address according to Modbus RTU protocol

 **Optional, available in MFM374-C only**

## Configuration

10

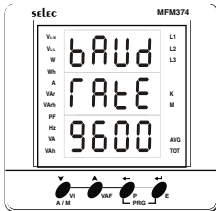

### Baud Rate

**Default Setting:** 9600.

**Range:** 300, 600, 1200, 2400, 4800, 9600 & 19200

**Note:** The baud rate could be one of the seven, 300, 600, 1200, 2400, 4800, 9600 & 19200

**Optional, available in MFM374-C only**

11



### Parity

**Default Setting:** None

**Range:** None, Even, Odd

**Note:** For asynchronous communication, user can select any one of three None, Even, Odd

**Optional, available in MFM374-C only**

12

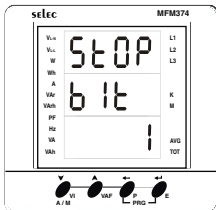

### Stop Bit

**Default Setting:** 1

**Range:** 1 or 2

**Note:** For asynchronous communication, user can select any one from '1 or 2'

**Optional, available in MFM374-C only**

## Configuration

13



### Maximum Auto Page

**Default Setting:** 19

**Range:** 1 to 19

**Note:** User can select maximum number of pages being displayed on the unit in auto mode.

14



### Change Page Sequence

**Default Setting:** No

**Range:** No / Yes

**Note:** User can change page sequence by selecting 'Yes'

**If option selected is 'No' the configuration will move to factory default page.**

15

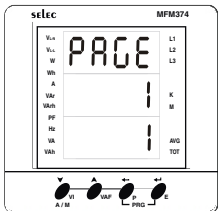

### Page Sequence

**Note:** Page sequence depends on maximum page selection.

User will be prompted to change page sequence depending upon maximum page selection defined.

## Configuration

16

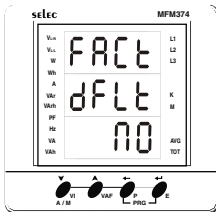

### Factory Default

**Default Setting:** No

**Range:** No / Yes

**Note:** If 'Yes' selected unit will be formatted to factory default settings. User should note all previous settings before formatting the unit.

17

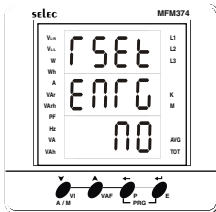

### Reset

**Default Setting:** No

**Range:** No / Yes

**Note:** For resetting energy parameters user has to select 'Yes' option. If option selected is 'No' the configuration will move to change password.

18

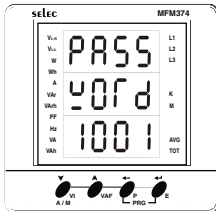

### Password

**Default Setting:** 1001

**Selection:** 0000 To 9999

**Note:** For resetting energy parameters user will be prompted the password. If correct password is entered, the user will be able to reset all energy parameters. This password will be a value which will be greater than the configuration password by 1.

## Configuration

19

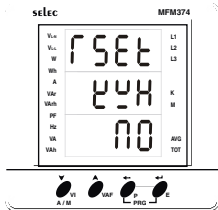

**Reset Active Energy**  
**Default Setting:** No  
**Selection:** No / Yes

**Note:** User can reset energy by selecting 'Yes'.  
 User should note the reading before resetting

20

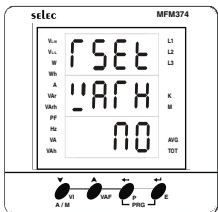

**Reset Reactive Energy**  
**Default Setting:** No  
**Selection:** No / Yes

**Note:** User can reset energy by selecting 'Yes'.  
 User should note the reading before resetting

21



**Reset Apparent Energy**  
**Default Setting:** No  
**Selection:** No / Yes

**Note:** User can reset energy by selecting 'Yes'.  
 User should note the reading before resetting.

**After pressing enter key configuration will move on to change password page.**

## Application of Pulse Output

## • Process Integration

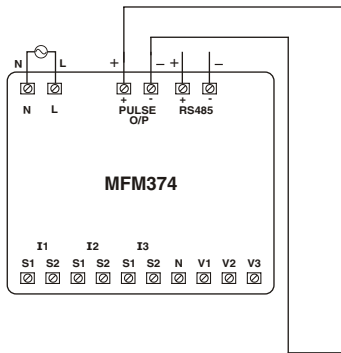

Pulse output from MFM374 meter can be interfaced into a process through a PLC for on line control of energy content in the process. If the PLC has a self excited 24V digital input, external 24V DC supply is not needed.

The kWh pulse is also used to derive average kWh information at the PLC.

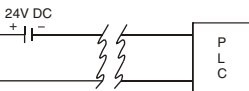

## • Energy Controller

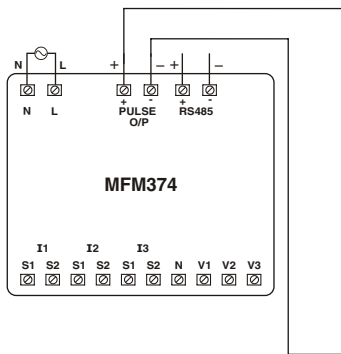

Pulse output from MFM374 meter can be used as alarm generator or total energy controller by interfacing it with presettable counter and control circuits (Contactors, Relay, Trip Circuit). The counter is loaded with the maximum energy consumption. When count reaches setpoint it provides output to control circuit to take appropriate action.

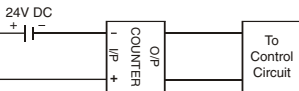

MODBUS register addresses list		
Readable parameters from MFM374:		
Address	Hex Address	Parameter
30000	0x00	Voltage V1N
30002	0x02	Voltage V2N
30004	0x04	Voltage V3N
30006	0x06	Average Voltage LN
30008	0x08	Voltage V12
30010	0x0A	Voltage V23
30012	0x0C	Voltage V31
30014	0x0E	Average Voltage LL
30016	0x10	Current I1
30018	0x12	Current I2
30020	0x14	Current I3
30022	0x16	Average Current
30024	0x18	kW1
30026	0x1A	kW2
30028	0x1C	kW3
30030	0x1E	kVA1
30032	0x20	kVA2
30034	0x22	kVA3
30036	0x24	kVAr1
30038	0x26	kVAr2
30040	0x28	kVAr3
30042	0x2A	Total kW
30044	0x2C	Total kVA





## MODBUS register addresses list *continued*

### Readable parameters from MFM384:

Address	Hex Address	Parameter
30046	0x2E	Total kVAr
30048	0x30	PF1
30050	0x32	PF2
30052	0x34	PF3
30054	0x36	Average PF
30056	0x38	Frequency
30058	0x3A	kWh
30060	0x3C	kVAh
30062	0x3E	kVArh

### Readable / writable parameters from MFM374:

Address	Hex Address	Parameter
40000	0x00	Password
40001	0x01	N/W selection
40002	0x02	CT Secondary
40003	0x03	CT primary (CT Secondary = 5)
		CT primary (CT Secondary = 1)
40004	0x04	PT Secondary
40005	0x05	PT primary

		Length (Register)	Data Structure
		2	Float
		2	Float
		2	Float
		2	Float
		2	Float
		2	Float
		2	Float
		2	Float
		2	Float
		2	Float
Range		Length (Register)	Data Structure
Min value	Max value		
0	9998	1	Integer
Value	Meaning		
0	3P-4W	1	Integer
1	3P-3W	1	Integer
Min Value	Max Value		
1	5	1	Integer
5	10000	1	Integer
1	10000		
100	500	1	Integer
100	500kV	2	Integer

MODBUS register addresses list *continued*

## Readable parameters from MFM374

Address	Hex Address	Parameter
40007	0x07	Slave Id
40008	0x08	Baud rate
40009	0x09	Parity
40010	0x0A	Stop bit
40011	0x0B	Factory Default
40012	0x0C	Reset kWh
40013	0x0D	Reset kVAh
40014	0x0E	Reset kVArh

Range		Length (Register)	Data Structure
Write Value	Meaning		
Min Value	Max Value		
1	255	1	Integer
Value	Meaning		
0x0000	300	1	Integer
0x0001	600		
0x0002	1200		
0x0003	2400		
0x0004	4800		
0x0005	9600		
0x0006	19200		
Value	Meaning		
0x0000	None	1	Integer
0x0001	Odd		
0x0002	Even		
Value	Meaning	1	Integer
0x0000	1		
0x0001	2		
1	Set to factory setting range	1	Integer
Value	Meaning		
1	Reset Total Active Energy	1	Integer
1	Reset Total Apparent Energy	1	Integer
1	Reset Total Reactive Energy	1	Integer

MODBUS register addresses list *continued*

## Readable parameters from MFM374

Address	Hex Address	Parameter
40015	0x0F	Auto Mode Pgs
40016	0x10	Page Address Sequence
40017	0x11	Page Address Sequence
40018	0x12	Page Address Sequence
40019	0x13	Page Address Sequence
40020	0x14	Page Address Sequence
40021	0x15	Page Address Sequence
40022	0x16	Page Address Sequence
40023	0x17	Page Address Sequence
40024	0x18	Page Address Sequence
40025	0x19	Page Address Sequence
40026	0x1A	Page Address Sequence
40027	0x1B	Page Address Sequence
40028	0x1C	Page Address Sequence
40029	0x1D	Page Address Sequence
40030	0x1E	Page Address Sequence
40031	0x1F	Page Address Sequence
40032	0x20	Page Address Sequence
40033	0x21	Page Address Sequence
40034	0x22	Page Address Sequence



## Description of Parameter & Symbols

1. **VOLTAGE:** True RMS value of three phase voltage, three line to line voltages and their average values are measured and displayed on MFM374.
2. **CURRENT:** True RMS value of three phase currents and their average are measured and displayed in MFM374. There is also Bar graph presentation for current in percentage form.
3. **POWER FACTOR:** Individual and average power factor displayed on MFM384
4. **ACTIVE POWER (P):** Three phase active power and system total active power are measured and displayed on MFM374.
5. **REACTIVE POWER(Q):** Three phase reactive power and total reactive power of the system are measured and displayed on MFM374.
6. **APPARENT POWER (S):** Three phase apparent power and total apparent power of the system are measured and displayed on MFM374.
7. **FREQUENCY:** The frequency of available voltage input is measured as system frequency.
8. **ENERGY (kWh, kVArh, kVAh):** Total Active, Reactive and Apparent energy of the system is measured and displayed on MFM 374.
9. **PULSE O/P:** DC pulse output is generated by the MFM374 which can be used to interface MFM384 with SCADA systems.

Config page.	Function	Value or Selection	Factory Setting
	Password	_____	1000
1	Change Password	_____	No
1.1	New Password	_____	-
2	Network Selection	_____	3P4W
3	CT Secondary	_____	5
4	CT Primary	_____	00005
5	PT Secondary	_____	350
6	PT primary	_____	350
7	Slave Id	_____	001
8	Baud Rate	_____	9600
9	Parity	_____	None
10	Stop Bit	_____	1
11	Max Page Auto	_____	19
12	Change Page Sequence	_____	No
12.1	Page sequence 1	_____	1
12.2	Page sequence 2	_____	2
12.3	Page sequence 3	_____	3
12.4	Page sequence 4	_____	4
12.5	Page sequence 5	_____	5
12.6	Page sequence 6	_____	6
12.7	Page sequence 7	_____	7



<b>Config page.</b>	<b>Function</b>	<b>Value or Selection</b>	<b>Factory Setting</b>
12.8	Page sequence 8	_____	8
12.9	Page sequence 9	_____	9
12.10	Page sequence 10	_____	10
12.11	Page sequence 11	_____	11
12.12	Page sequence 12	_____	12
12.13	Page sequence 13	_____	13
12.14	Page sequence 14	_____	14
12.15	Page sequence 15	_____	15
12.16	Page sequence 16	_____	16
12.17	Page sequence 17	_____	17
12.18	Page sequence 18	_____	18
12.19	Page sequence 19	_____	19





← button, the eighth screen shows:

Active, reactive, apparent  
Total kW, kVAr, kVA)

3 wire system only Total kW, kVA,  
kVAr can be displayed

← button, the first screen shows:

Active energy (Total kWh)

There are 8 digit for energy  
Total kWh will be displayed in 2 rows, 4 digits in  
each row. Lsb on middle row & msb on top row  
Total energy accumulated is 12345.6, top row will  
display 12345 and middle row will display 345.6

← button, the second screen shows:

Active energy (Total kVAh)

There are 8 digit for energy  
Total kVAh will be displayed in 2 rows, 4 digits in  
each row. Lsb on middle row & msb on top row  
Total energy accumulated is 12345.6, top row will  
display 12345 and middle row will display 345.6

## Online Page Description

19

X3

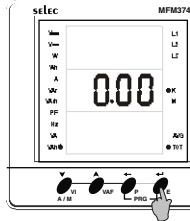

Press E (←)

✓ Total app

**Note:** 1) Total  
Energy will be  
displayed with  
lsb on middle  
row. Eg: if energy  
accumulated is 12345.6,  
top row will display 12345  
& middle row will display 345.6

A/M

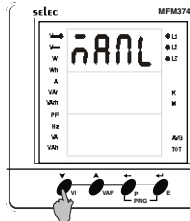

Press VI (←)

between A/M  
& E. In auto mode,  
the rate of energy  
accumulated is 12345.6,  
top row will display 12345  
& middle row will display 345.6

## Configuration

There are 4 dedicated keys labelled as VI, VAr, PF, & E, for entering the configuration menu / change setting.

**Note:** The settings should be done by a professional technician after manual and having understood the application. For the configuration setting mode

- Use ← + ← keys for 3 sec to enter or exit the configuration mode
- Use ▲ or ▼ keys for increasing or decreasing the setting
- Use ← key to go back to previous page
- Use ← key to save the setting and move to next page

# Content

*Operating / 1009 / MFM374 / Ver1, OP300-V01.*

---

## **Selec Controls Pvt. Ltd., India,**

**Tel:** 91-22-28471882 / 4039 4200 / 4039 4202

**Tollfree:** 1800 227 353    **Fax:** 91-22-28471733,

**Website:** [www.selec.com](http://www.selec.com)

**E- mail:** [sales@selec.com](mailto:sales@selec.com)